



**Blade R** All in one



**Invisible source,  
ultimate comfort.**



# Functional and formal integration in architecture.

From chaos to order: Blade R integrates, simplifies and restores purity and harmony in ceilings.  
Absolute, functional and formal integration.

32 devices without Blade R



11 Blade R





Blade R is a masterpiece of precision that integrates perfectly into architecture as never before: a jewel of precision that turns light into an element of formal and functional fusion with architecture. Architects designing spaces have the task of combining elements and functions through harmonious integration, thereby ensuring overall value and liveability of the architectural environment for users. While furnishings can be designed within the same space and, consequently, be fully integrated into the context, other functional and

technological elements are often already available on the market with specific designs that do not always allow formal harmony between themselves and within the architectural setting. Blade R seeks to respond to this dual need for functional and formal integration. More advantages and more functions in a single product. The first advantage is that people live in a "cleaner" space while also enjoying many other services, in addition to lighting. All in One.

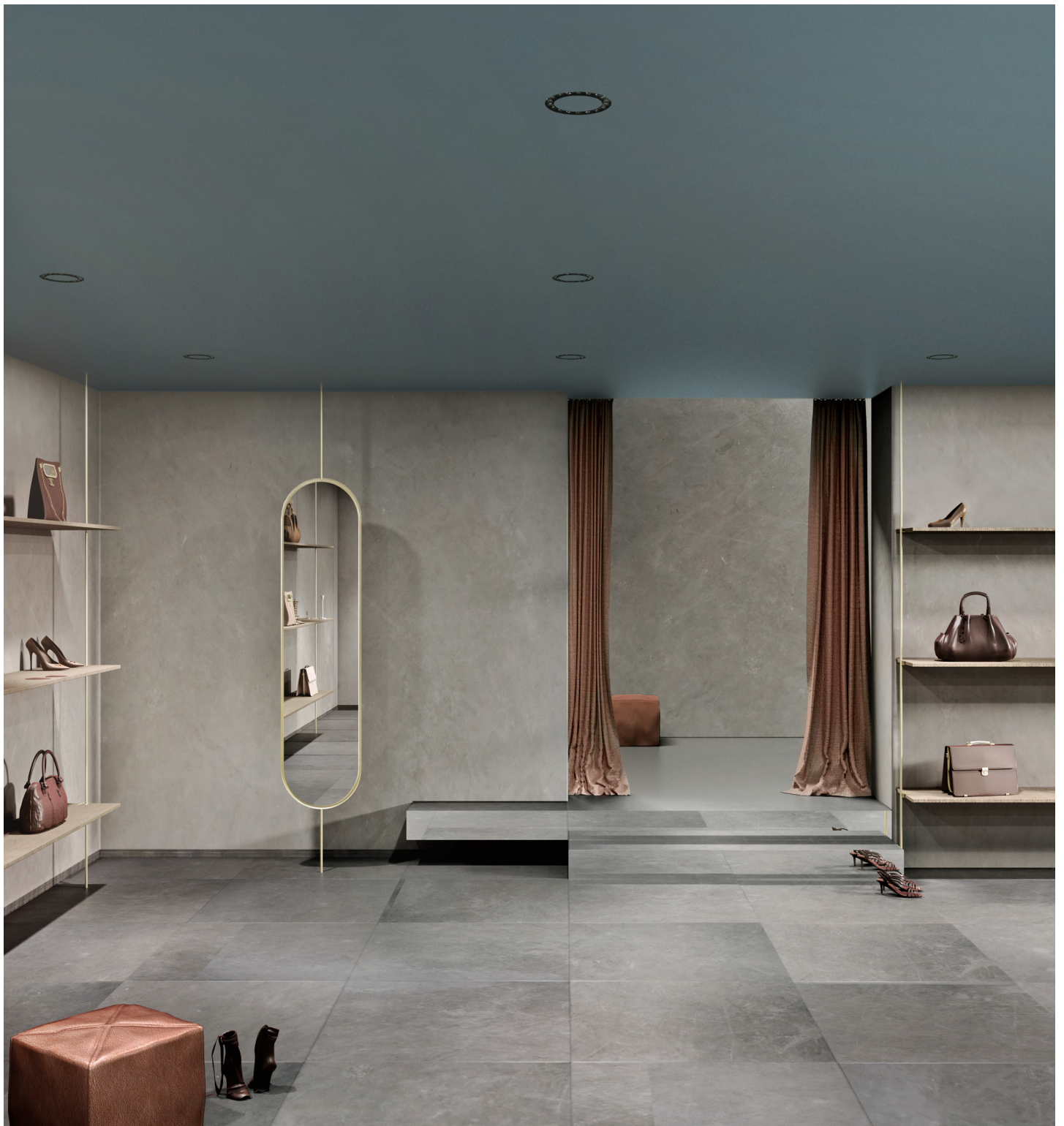

## Light beyond light.

Blade R satisfies numerous space requirements, complying with safety standards and meeting changing trends in user behaviour.





## Extreme reliability.

The performance of the Blade R luminaires has been tested and certified in compliance with existing regulations to guarantee their functionality, even when other devices are attached.

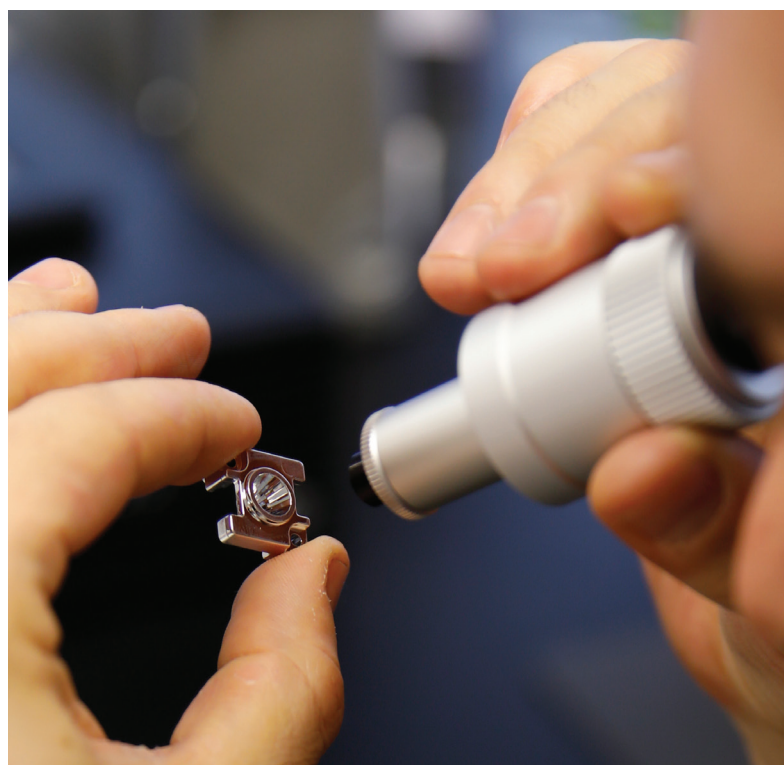
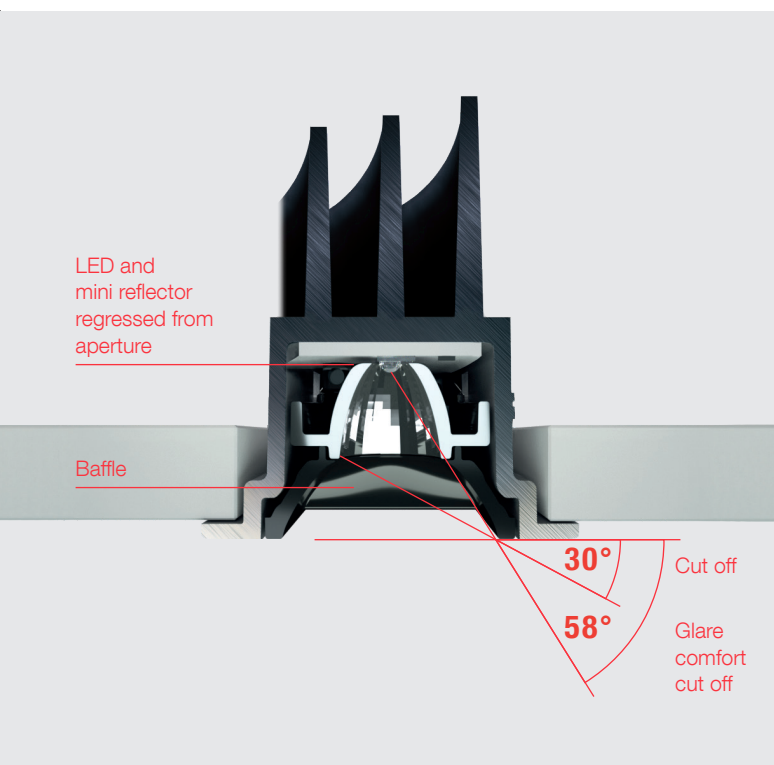
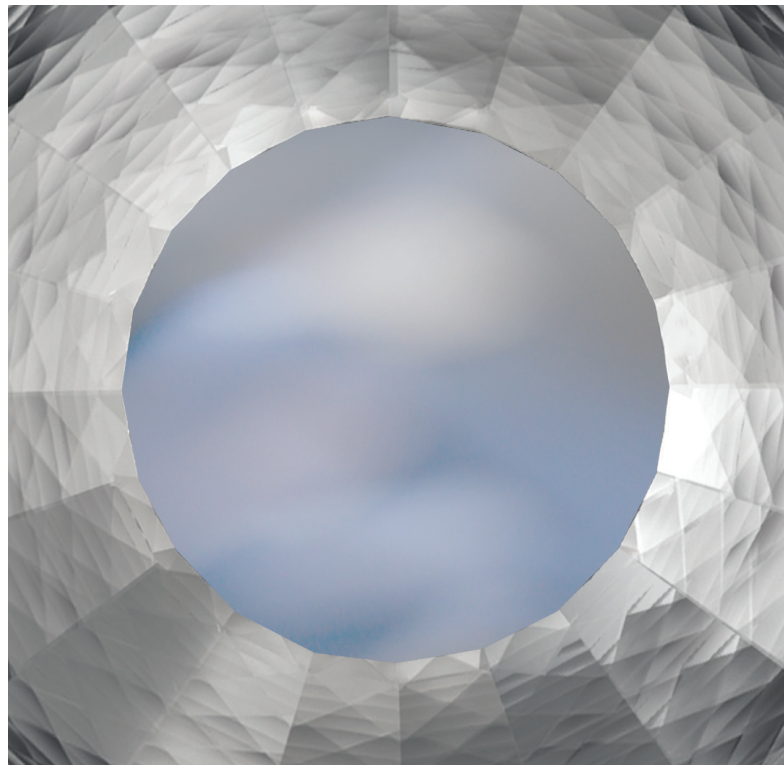
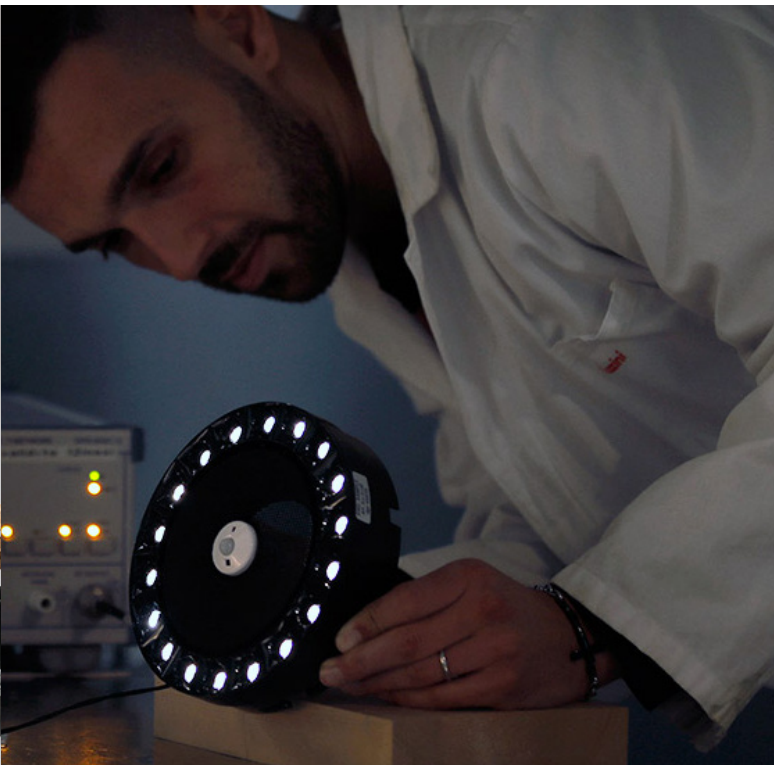







# Overview

## Blade R

6 cells  
16 W / 870 lm

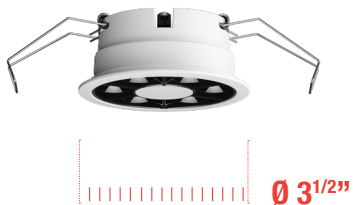

12 cells  
29 W / 1 675 lm

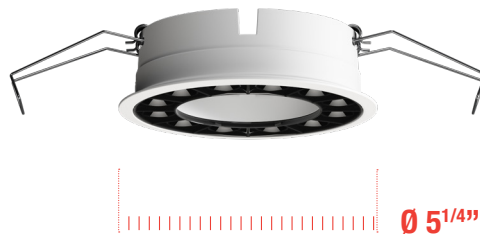

## Blade R

18 cells  
39,5 W / 2 650 lm

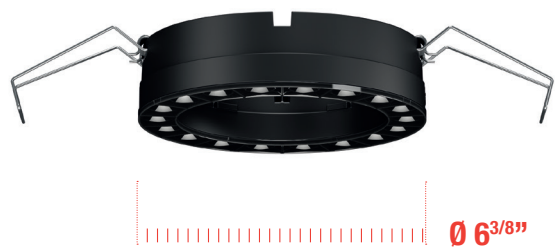
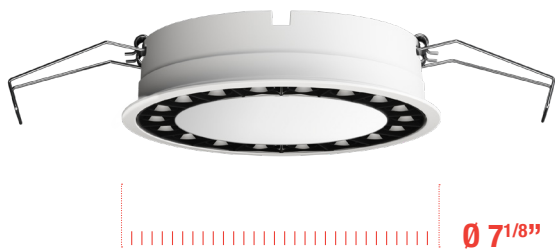

30 cells  
60,5 W / 3 770 lm

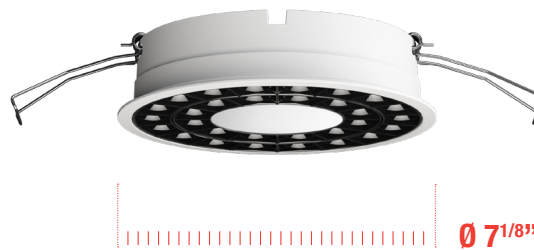

Trim / Trimless (Except Blade R 30 cells)  
24° / 40° / 58°  
2700/3000/3500K - CRI 90  
4000K - CRI 80/90





**Entertainment**

**Sustainability**

**Better Light**

**Safety**

**Smart solutions**

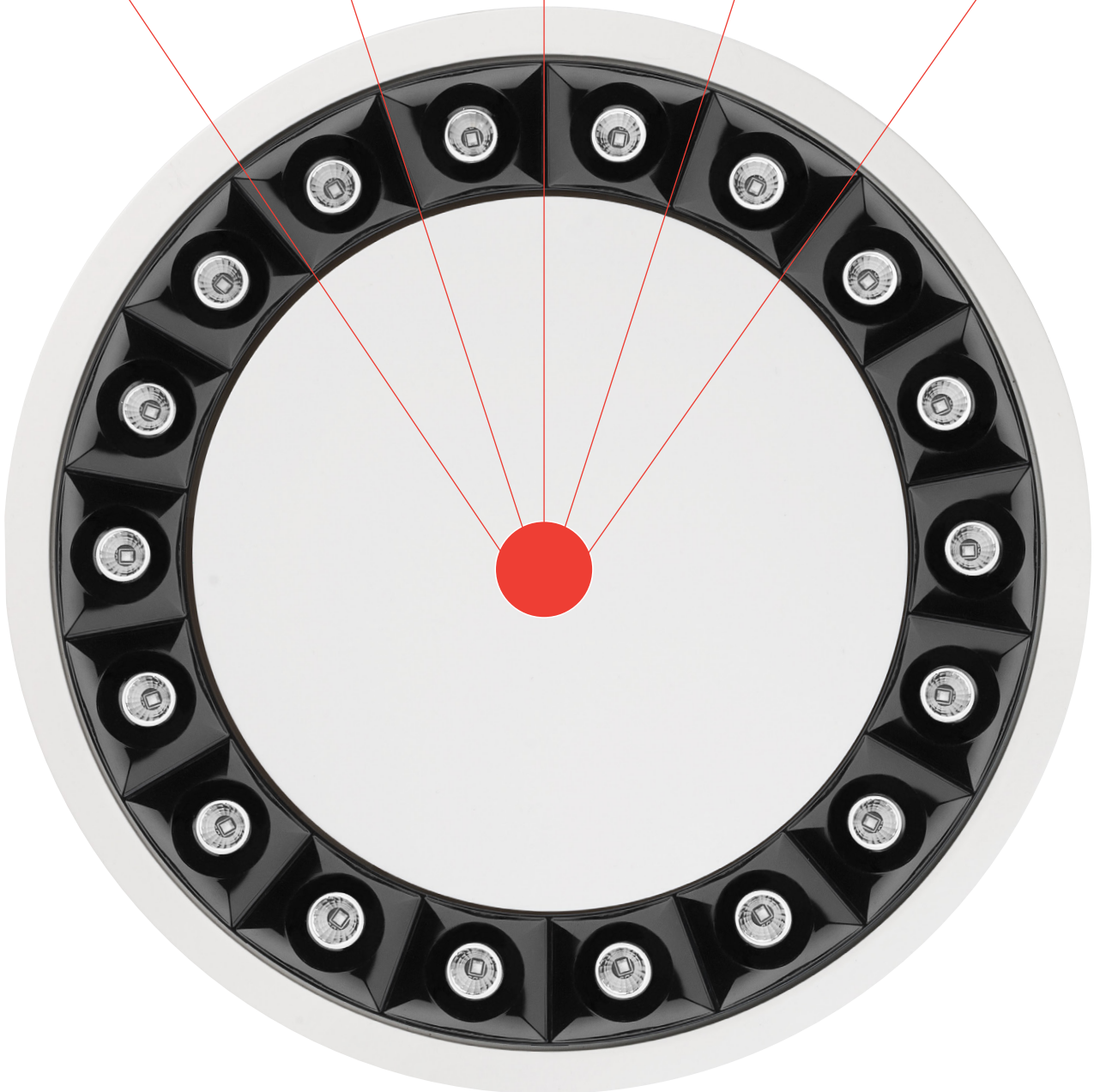

Scale 1:1

**Blade R further develops the concept of integration in architecture to promote human wellbeing by enabling security and entertainment services, comfort and sustainability, all in a smart way.**

# Overview

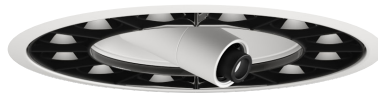

## Blade R

**6 cells**  
16 W / 870 lm



**12 cells**  
29 W / 1 675 lm



## Accessories



Cover

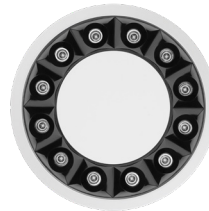

Cover

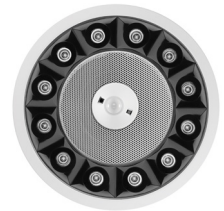

Multiple sensors



Palco Framer ø 19 mm



At launch, please take note that only the cover accessories will be available for the North American market.

As required certifications resume, we invite you to contact a member of our team for future availability inquiries, or to visit the [www.iguzzini.com/us](http://www.iguzzini.com/us)



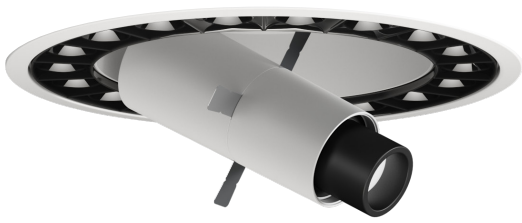

## Blade R

**18 cells**  
39,5 W / 2 650 lm



**30 cells**  
60,5 W / 3 770 lm



## Accessories



Cover

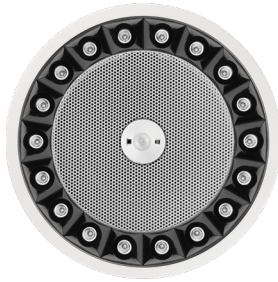

Multiple sensors



Speaker

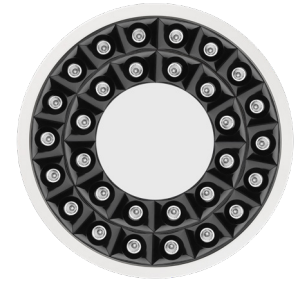

Cover



Video camera\*\*



Palco Framer ø 37 mm

## Finishes



31  
White



02  
Black



31  
White/  
White



01  
White/  
Black



02  
Black/  
Black



10\*  
Gray/  
Black



\*  
Burnished  
chrome



\*  
Gold



\*  
White/  
gold



\*  
White/  
Burnished  
chrome

\* Versions available on request







